

Spezifikation für Freigabe / specification for release

Kunde / customer : _____
 Artikelnummer / part number : **7445110**
 Bezeichnung : **SPEICHERDROSSEL WE-PD 3**
 description : **POWER-CHOKE WE-PD 3**



DATUM / DATE : 2005-06-21

A Mechanische Abmessungen / dimensions:

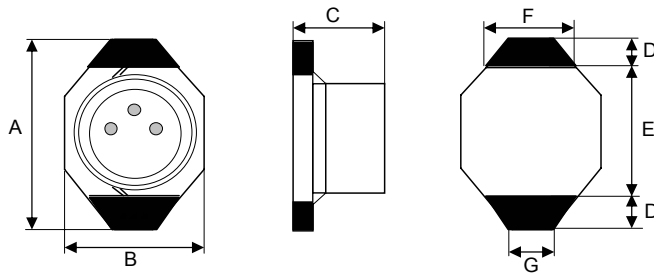

Marking = Inductance code

| | Typ S | |
|---|------------------|----|
| A | 6,60 max. | mm |
| B | 4,45 max. | mm |
| C | 2,92 max. | mm |
| D | 1,0 ref. | mm |
| E | 4,32 ref. | mm |
| F | 3,05 ref. | mm |
| G | 1,27 ref. | mm |

B Elektrische Eigenschaften / electrical properties:

| Eigenschaften / properties | Testbedingungen / test conditions | | Wert / value | Einheit / unit | tol. |
|--|---|----------------------|--------------|----------------|-------------|
| Induktivität / inductance | 100 kHz / 0,1V | L | 10,00 | μ H | $\pm 20\%$ |
| DC-Widerstand / DC-resistance | @ 20°C | $R_{DC \text{ typ}}$ | 0,056 | Ω | typ. |
| DC-Widerstand / DC-resistance | @ 20°C | $R_{DC \text{ max}}$ | 0,075 | Ω | max. |
| Nennstrom / rated current | $\Delta T = 40 \text{ K}$ | I_{DC} | 1,000 | A | max. |
| Sättigungsstrom / saturation current | $\Delta L/L < 10\%$ | I_{sat} | 0,450 | A | typ. |
| Eigenres.-Frequenz / self-res.-frequency | | SRF | 38,00 | MHz | typ. |

C Lötpad / soldering spec.:

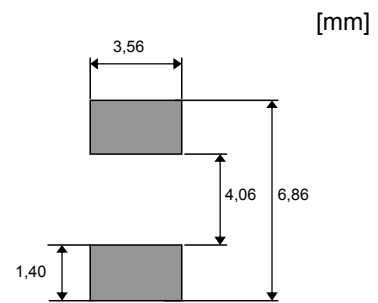

D Prüfgeräte / test equipment:

HP 4274 A für/for L und/and Q
HP 34401 A für/for I_{DC} und/and R_{DC}

E Testbedingungen / test conditions:

Luftfeuchtigkeit / humidity: 33%
 Umgebungstemperatur / temperature: +20°C

F Werkstoffe & Zulassungen / material & approvals:

Basismaterial / base material: Ferrit / ferrite
 Draht / wire: 2SFBW 155°C
 Sockel / Base: Keramik / ceramic
 Endoberfläche / finishing electrode: 100% Au

G Eigenschaften / granted properties:

Betriebstemp. / operating temperature: -40°C - +125°C
 Umgebungstemp. / ambient temperature: -40°C - +85°C
 It is recommended that the temperature of the part does not exceed 125 °C under worst case operating conditions

| | | | | |
|-------------------------------------|-------------------|--------------------------|------|---|
| Freigabe erteilt / general release: | Kunde / customer | | | |
| | Datum / date | Unterschrift / signature | | |
| | Würth Elektronik | | | |
| | | | SST | Version 5 2005-06-21 |
| | | | MST | Version 4 2004-10-11 |
| | | | MST | Version 1 2004-06-03 |
| | | | Name | Änderung / modification Datum / date |
| | Geprüft / checked | Kontrolliert / approved | | |

Würth Elektronik eiSos GmbH & Co. KG

D-74638 Waldenbug · Max-Eyth-Strasse 1 - 3 · Germany · Telefon (+49) (0) 7942 - 945 - 0 · Telefax (+49) (0) 7942 - 945 - 400
<http://www.we-online.com>

Spezifikation für Freigabe / specification for release

Kunde / customer : _____
 Artikelnummer / part number : **7445110**
 Bezeichnung : **SPEICHERDROSSEL WE-PD 3**
 description : **POWER-CHOKE WE-PD 3**

LF



DATUM / DATE : 2005-06-21

H Induktivitätskurve / Inductance curve:

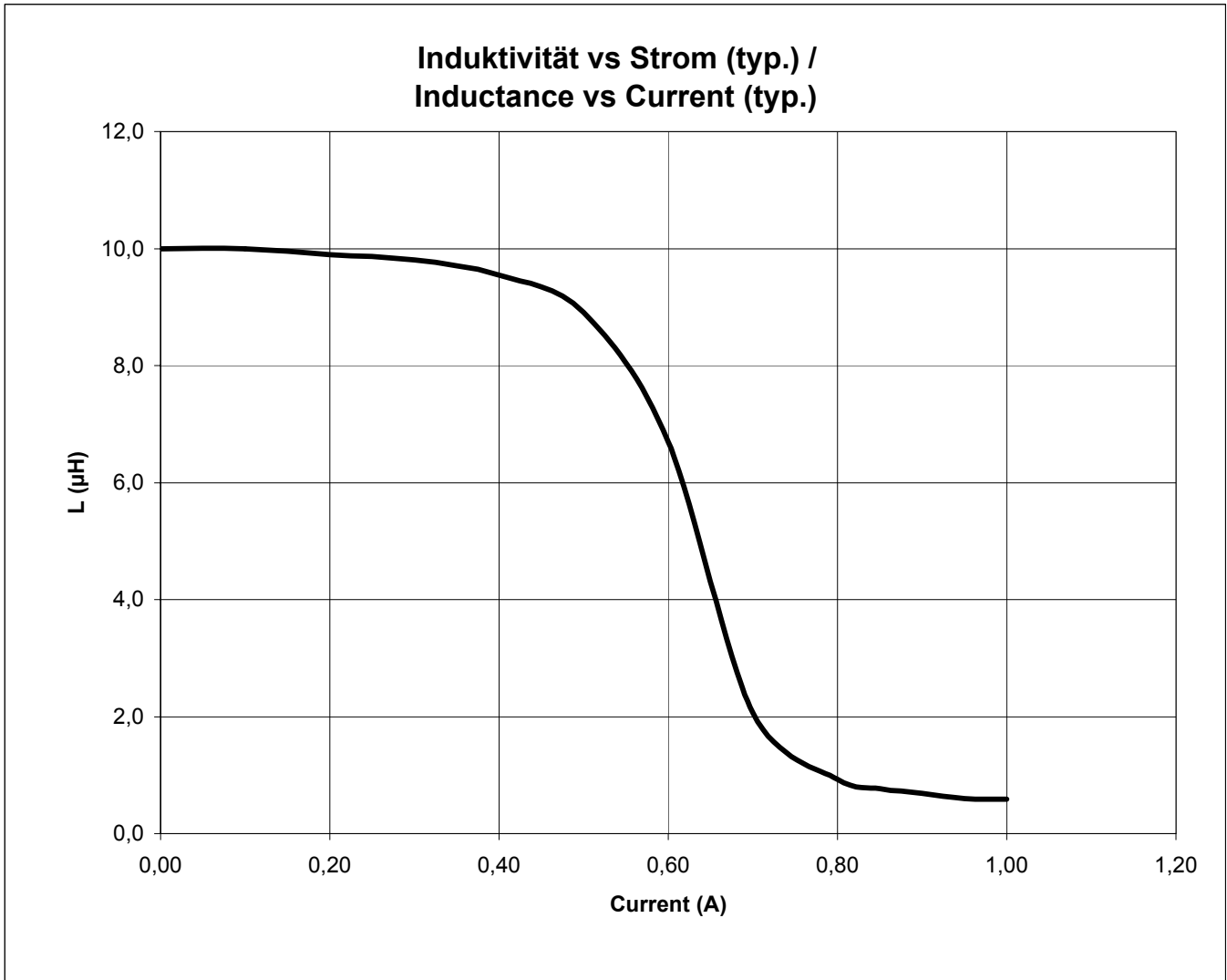

| | | | | |
|-------------------------------------|--------------------------|------|-------------------------|--------------|
| Freigabe erteilt / general release: | Kunde / customer | | | |
| | | | | |
| Datum / date | Unterschrift / signature | | | |
| | Würth Elektronik | SST | Version 5 | 2005-06-21 |
| | | MST | Version 4 | 2004-10-11 |
| | | MST | Version 1 | 2004-06-03 |
| Geprüft / checked | Kontrolliert / approved | Name | Änderung / modification | Datum / date |

Würth Elektronik eiSos GmbH & Co. KG

D-74638 Waldenbug · Max-Eyth-Strasse 1 - 3 · Germany · Telefon (+49) (0) 7942 - 945 - 0 · Telefax (+49) (0) 7942 - 945 - 400
<http://www.we-online.com>

Spezifikation für Freigabe / specification for release

Kunde / customer : _____
 Artikelnummer / part number : **7445110**
 Bezeichnung : **SPEICHERDROSSEL WE-PD 3**
 description : **POWER-CHOKES WE-PD 3**

LF



DATUM / DATE : 2005-06-21

I Rollenspezifikation / Tape and reel specification:

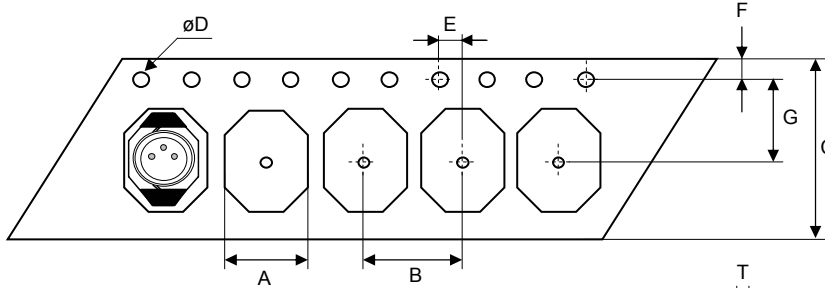

Gurtspezifikation / Tape specification:

| | | |
|---|-------------|----|
| A | 4,40 ± 0,1 | mm |
| B | 8,00 ± 0,1 | mm |
| C | 16,0 ± 0,3 | mm |
| D | 1,50 ± 0,1 | mm |
| E | 2,00 ± 0,1 | mm |
| F | 1,75 ± 0,1 | mm |
| G | 7,50 ± 0,1 | mm |
| H | 6,75 ± 0,1 | mm |
| I | 3,20 ± 0,1 | mm |
| T | 0,30 ± 0,05 | mm |

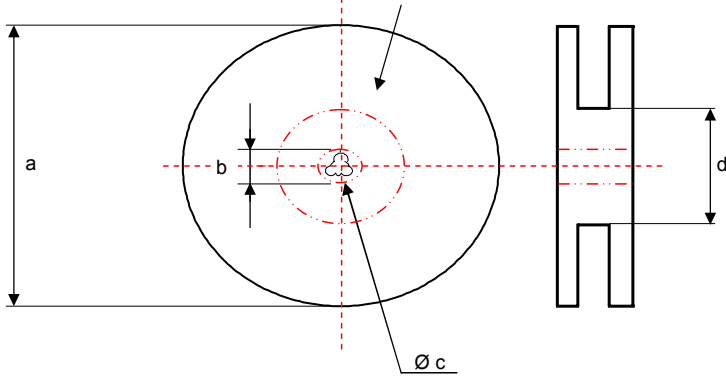
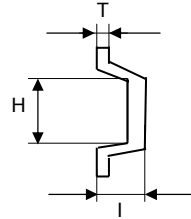

Rollenspezifikation / Reel specification:

| | | |
|---|---------------------------------------|----|
| a | 330,0 ± 0,5 | mm |
| b | 20,20 ± 0,2 | mm |
| c | 13,00 ^{+0,5} _{-1,0} | mm |
| d | 100,0 ± 0,2 | mm |

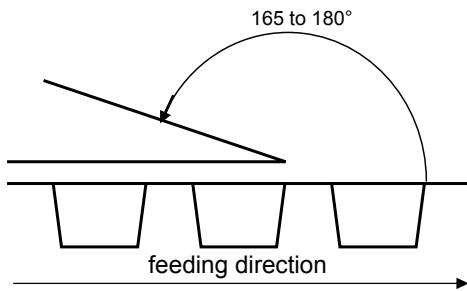

The force for tearing off cover tape is 10 to 130 grams in arrow direction

| | | | |
|-------------------------------------|--------------------------|-------------------------|--------------|
| Freigabe erteilt / general release: | Kunde / customer | | |
| | | | |
| Datum / date | Unterschrift / signature | | |
| Geprüft / checked | Würth Elektronik | | |
| | Kontrolliert / approved | | |
| | Name | Änderung / modification | Datum / date |
| | SST | Version 5 | 2005-06-21 |
| | MST | Version 4 | 2004-10-11 |
| | MST | Version 1 | 2004-06-03 |

This electronic component is designed and developed with the intention for use in general electronics equipments. Before incorporating the components into any equipments in the field such as aerospace, aviation, nuclear control, submarine, transportation, (automotive control, train control, ship control), transportation signal, disaster prevention, medical, public information network etc. where higher safety and reliability are especially required or if there is possibility of direct damage or injury to human body. In addition, even electronic component in general electronic equipments, when used in electrical circuits that require high safety, reliability functions or performance, the sufficient reliability evaluation-check for the safety must be performed before use. It is essential to give consideration when to install a protective circuit at the design stage.

Würth Elektronik eiSos GmbH & Co. KG

D-74638 Waldenbug · Max-Eyth-Strasse 1 - 3 · Germany · Telefon (+49) (0) 7942 - 945 - 0 · Telefax (+49) (0) 7942 - 945 - 400
<http://www.we-online.com>